

# WSV10U100S, WSAT10U100S, WSCT10U100S, WSR10U100S-HAF

## Silicon Epitaxial Trench Schottky Barrier Rectifiers

**Reverse Voltage - 100 V**  
**Forward Current - 10 A**

### Features

- Low forward voltage drop, low power losses
- High efficiency operation
- Halogen and Antimony Free(HAF), RoHS compliant

### Applications

- For use in high frequency converters
- Switching power supplies
- Freewheeling diodes
- OR-ing diode
- DC/DC converters and reverse battery protection.

**WSV10U100S**

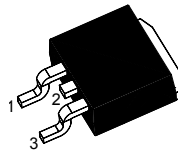

1.Anode 2.Cathode 3.Anode  
**TO-263 Plastic Package**

**WSAT10U100S**

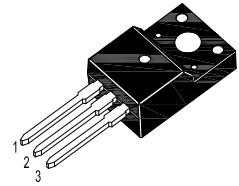

1.Anode 2.Cathode 3.Anode  
**TO-220F Plastic Package**

**WSCT10U100S**

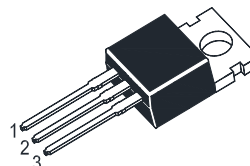

1.Anode 2.Cathode 3.Anode  
**TO-220FB Plastic Package**

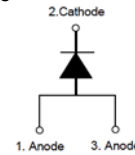

**WSR10U100S**

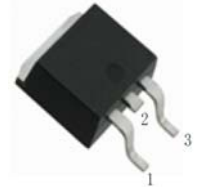

1.Anode 2.Cathode 3.Anode  
**TO-252 Plastic Package**

### Absolute Maximum Ratings ( $T_a = 25^\circ\text{C}$ unless otherwise specified)

Parameter	Symbol	Value	Unit
Maximum Repetitive Peak Reverse Voltage	$V_{RRM}$	100	V
Average Rectified Forward Current	$I_{F(AV)}$	10	A
Peak Forward Surge Current 8.3 ms Single half sine-wave Superimposed on Rated Load (JEDEC Method)	$I_{FSM}$	170	A
Junction Temperature	$T_j$	150	$^\circ\text{C}$
Storage Temperature Range	$T_{stg}$	- 55 to + 150	$^\circ\text{C}$

### Thermal Characteristics (at $T_a = 25^\circ\text{C}$ unless otherwise specified)

Parameter	Symbol	WSV10 U100S	WSAT10 U100S	WSCT10 U100S	WSR10 U100S	Unit
Typical Thermal Resistance-Junction to Case	$R_{\theta JC}$	3.5	4.5	3	4.5	$^\circ\text{C/W}$

### Electrical Characteristics (at $T_a = 25^\circ\text{C}$ unless otherwise specified)

Parameter	Symbol	Min.	Max.	Unit
Forward Voltage at $I_R = 10 \mu\text{A}$	$V_{BR}$	100	-	V
Forward Voltage at $I_F = 2 \text{ A}$	$V_F$	-	0.51	V
at $I_F = 3 \text{ A}$		-	0.51	
at $I_F = 5 \text{ A}$		-	0.57	
at $I_F = 10 \text{ A}$		-	0.73	
at $I_F = 15 \text{ A}$		-	0.85	
at $I_F = 20 \text{ A}$		-	0.97	
DC Reverse Current at $V_R = 100 \text{ V}$	$I_R$	-	100	$\mu\text{A}$

# WSV10U100S, WSAT10U100S, WSCT10U100S, WSR10U100S-HAF

## Electrical Characteristics Curves

Fig. 1 Forward Current vs. Forward Voltage

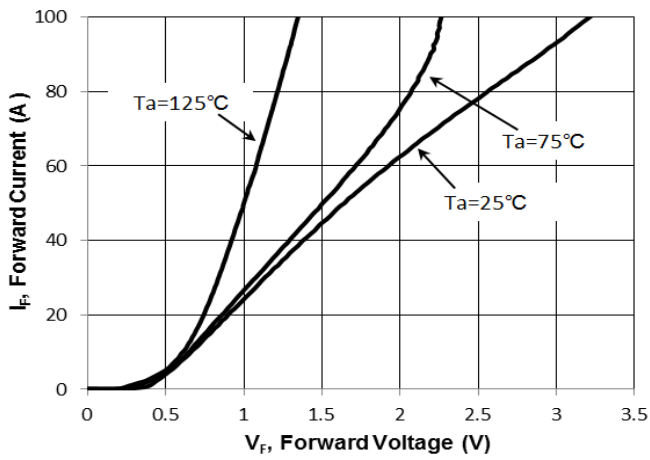

Fig. 2 Reverse Current vs. Reverse Voltage

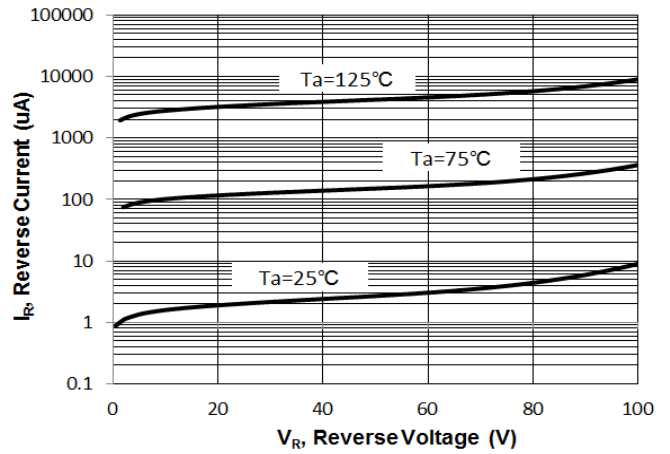

Fig. 3 Junction Capacitance vs. Reverse Voltage

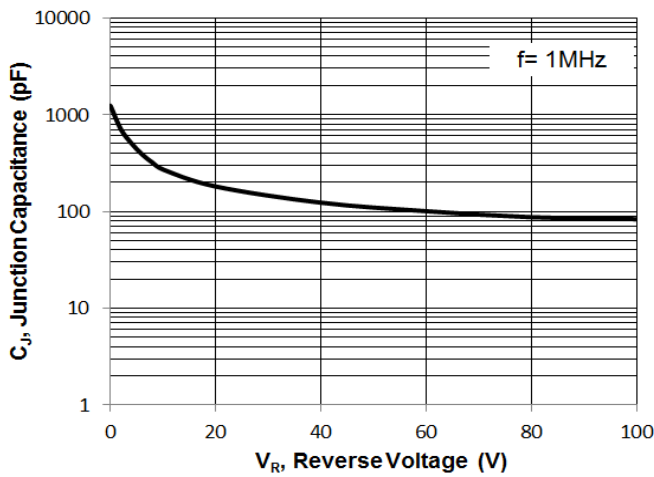
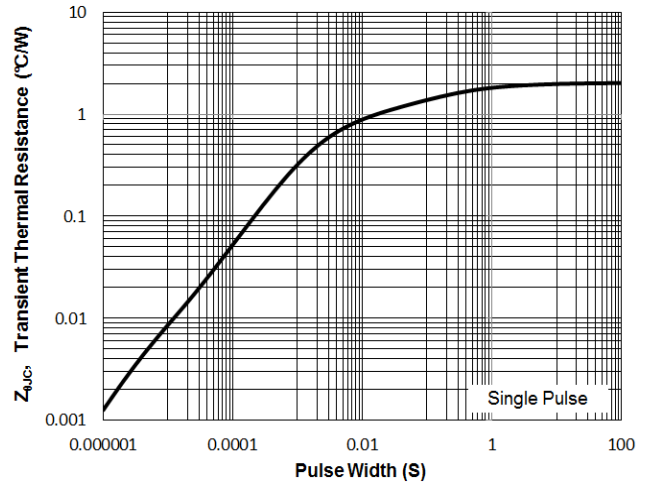
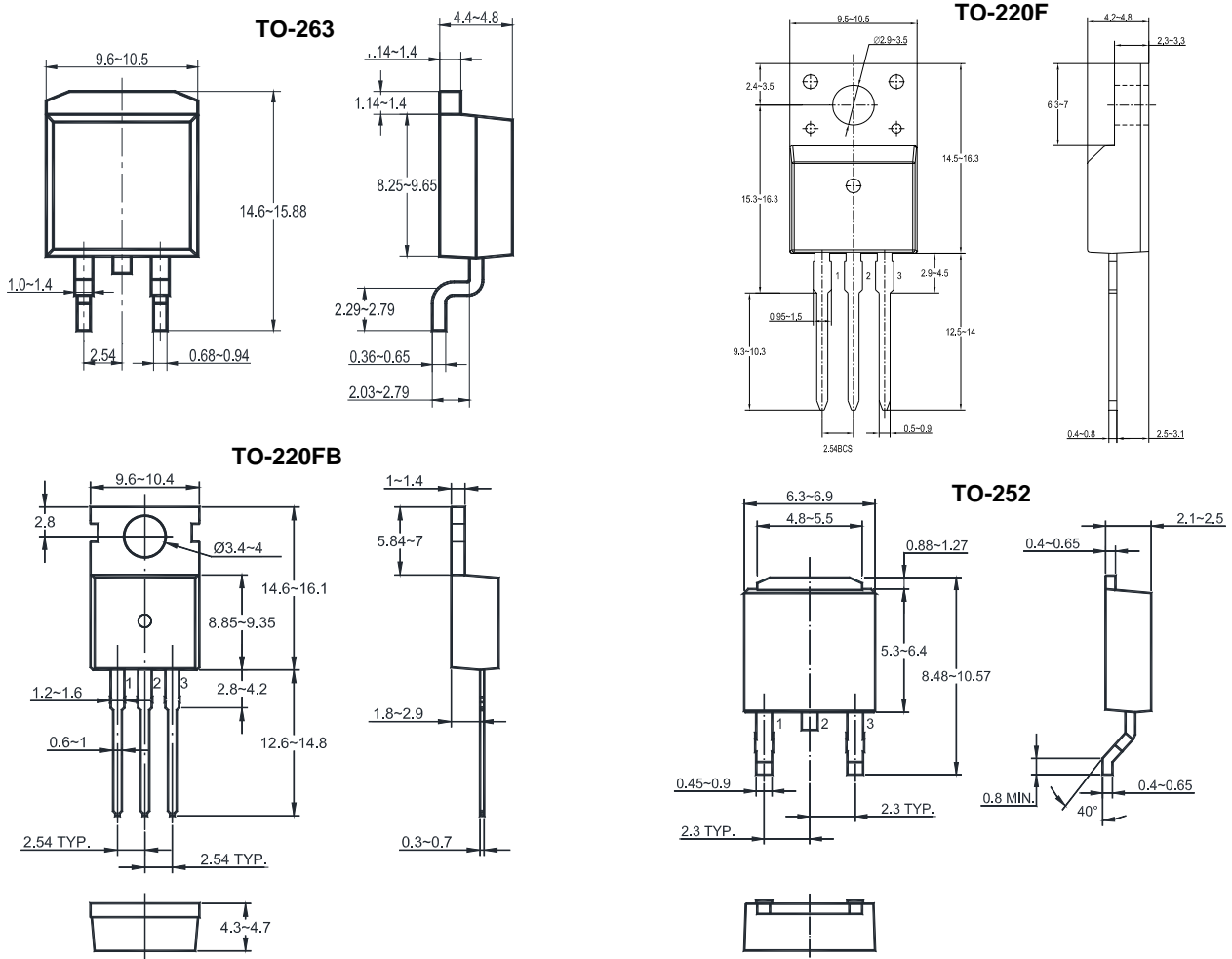

Fig. 4 Thermal Resistance



# WSV10U100S, WSAT10U100S, WSCT10U100S, WSR10U100S-HAF

## Package Outline Dimensions (Units: mm)



## Recommended Soldering Footprint

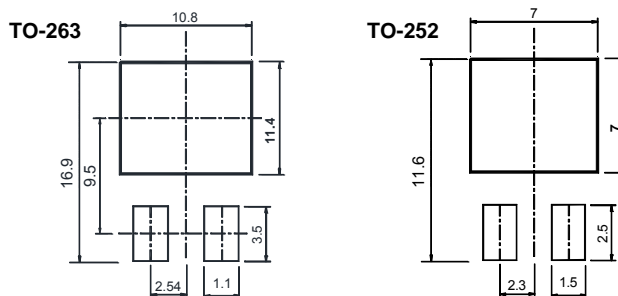

## Packing information

Package	Type	Carton Quantity	Box Quantity	Base Quantity	Delivery Mode
TO-263	WSV10U100S	5 K / Carton	1 K / Box	50 pcs / Tube	Tube
TO-220F	WSAT10U100S	5 K / Carton	1 K / Box	50 pcs / Tube	Tube
TO-220FB	WSCT10U100S	5 K / Carton	1 K / Box	50 pcs / Tube	Tube
TO-252	WSR10U100S	25 K / Carton	5 K / Box	2.5 K / Reel	Reel

## Marking information

"XXXXXXXXXX" = Part No.  
 "\*\*\*\*\*" = Date Code Marking  
 Font type: Arial

